

Master Key System Design Guide

ASSA ABLOY

Guidance and worksheets for use with ASSA ABLOY Group brands:
ABLOY | LOCKWOOD | MEDECO

The global leader in
door opening solutions



Introduction

To ensure a facility or building has the desired level of security, it is necessary to have a properly designed and maintained master key system. ASSA ABLOY Australia offers all of the products and services to help you implement a new master key system, or expand an existing one.

Key System Products

Product solutions include:

- Cylinders for various security requirements levels
- Cylinders that meet or exceed the Australian Standard AS 4145.2 2008
- Cylinders that work with electrified stand-alone and networked access control systems

Professional Support

Our team of trained Key and Door Specification System Specialists will help you design a secure master key system, develop and implement key control policies, select the right cylinder for each doorway, and understand the latest trends in physical security. As the leader in security and safety solutions, ASSA ABLOY has the know how and expertise to assist with any security requirement for your premises.

Design Guides

Master Key System Design Guide: In addition to the support provided by our team, this design guide can help you plan and apply a master key system. It takes you through the entire process and includes a glossary of master key system terms and worksheets to assist in the layout phase.

Key Control Guide: To extend the life and value of a key system, correct key control policies must be in place. ASSA ABLOY offers a comprehensive key control guide that will help you design policies and procedures for your facility.

Learn More

Contact the Key System Specialist of your local ASSA ABLOY Australia team to learn more about our products, services and training programs, and to get a copy of the Key Control Guide.

Table of Contents

Planning

Convenience vs. Security, Achieving Proper Balance	3
System Structure	4
Levels of Keying	4
2-Level System	5
3-Level System	5
4-Level System	5

Key Symbols

Standard Key Symbols	6
2-Level System	6
3-Level System	6
Grand Master Pie "A"	7
4-Level System	8
Special Keying Requirements, Larger Systems	8

System Expansion

Define Expansion Parameters.	9
Sample Expansion Specification.	9
What You Must Know.	9
Theoretical Numbers Reduced	9
Cross Keying	10

Step by Step

Designing Master Key Systems	11-12
--	-------

Glossary and Keying Levels

Terms & Definitions	13-16
Levels of Keying	17

System Design Worksheet

System Design Worksheet (Level 3)	18
Sample System Design Worksheet (Level 3)	19

Careful planning is key to the long-term success and life of a master key system. Planning starts with understanding the opposing forces of security and convenience, and creating the proper balance. From there, it's easy to move onto developing the key system structure.

Maximum Security

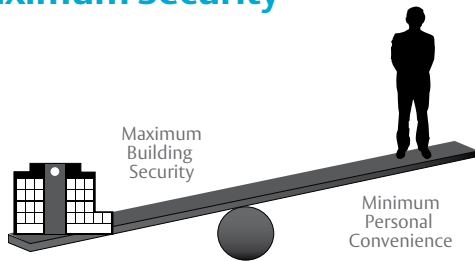

Some buildings will be heavily security oriented. Lack of convenience may make it hard to operate the building on a day to day basis

Maximum Convenience

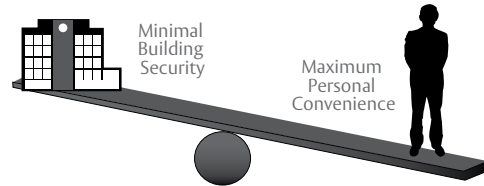

Some buildings will require great personal convenience. This takes away from building security.

Opposing Forces

The cylinder mechanism and the keying system must strike the right balance between two archrivals—security and convenience.

The type and amount of cross key, the use of keyed alike groups and the number of levels of keying all play critical roles in this delicate balance. They also directly affect the amount of expansion available in the system.

“Security”

- Keyed to Differ sets
- Small, unrelated systems
- Patented keyways
- Security cylinders
- High security cylinders
- Key control

“Convenience”

- Extensive cross keying
- One huge, complicated system
- Standard or non-protected keyway
- Many selective master keys
- No key control

Proper Balance

The simplest keying systems are often the most secure and will last longer than complicated ones. Cross keying and complicated systems reduce security and expansion potential. A system designed around personnel will inevitably have a shorter life than that of a system designed around a building or structure.



Planning

System Structure

Begin sketching out a key system schematic using descriptive terms appropriate for the job at hand. Typically these would be departments, buildings or geographic areas. It is not necessary to account for every change key at this early stage. The schematic often looks like an organizational chart.

When planning the system, don't forget the building core. Core areas are generally maintenance areas: stairwells, mechanical rooms, electrical, phone and HVAC (Heating, Ventilation and Air Conditioning) areas. Normally, individual

floor or department masters DO NOT operate these areas. Group them all under their own MK (or use changes under the grand, etc.).

Key all similar core areas alike: one key symbol for all electrical areas; a second one for all pipe chases; a third for all mechanical rooms, etc. This reduces the need to issue master keys to maintenance personnel. Once the structure is determined, the next step is to determine the level of keying.

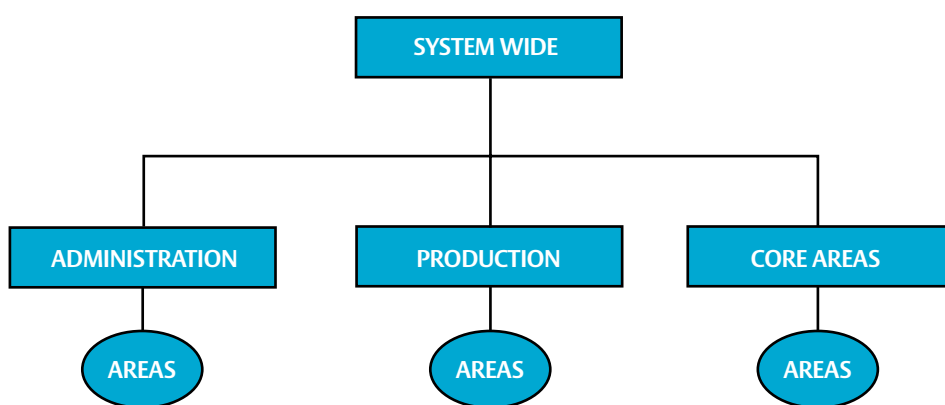

Levels of Keying

First, we must understand the concept of levels of keying. Think of it as levels of authority in an organization. All systems should have a structure like that of a corporate organizational chart.

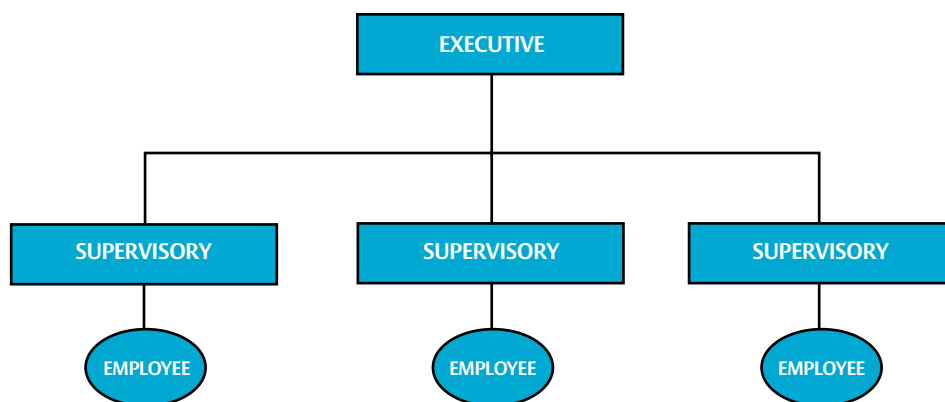

2-Level System

The simplest master key system has two levels of keying and is considered the lowest level of master keying. The less powerful keys at the bottom are called change keys. Each one operates only one lock, or one group of keyed alike locks. The more powerful key at the top is called the master key.

Even the largest, most complicated keying systems for hospitals and universities can be broken down into pieces that fit this simple model.

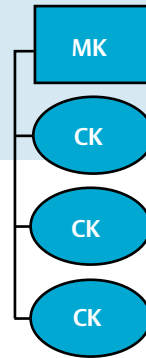

3-Level System

A 3-level system is nothing more than two or more 2-level systems tied together under a higher level key called a grand master key.

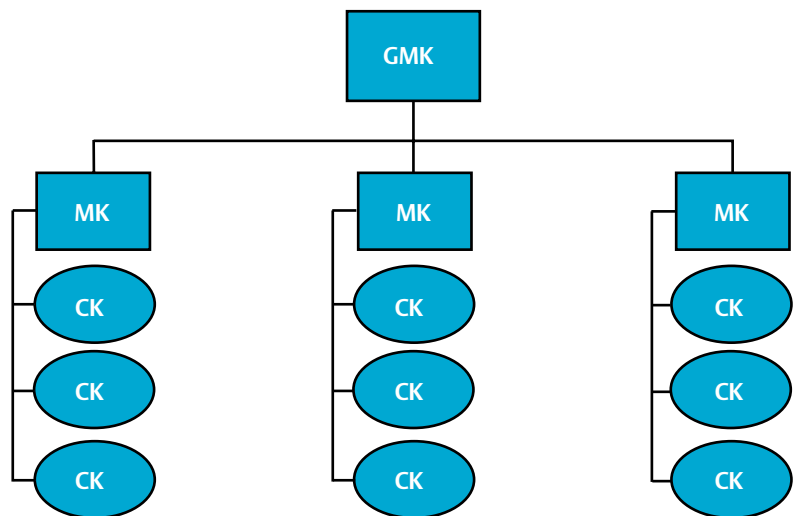

4-Level System

A 4-level system ties two or more 3-level systems together under a higher level key called a great grand master key.

Even though large jobs tend to require more levels of keying than small jobs, most systems do not need more than 4 levels of keying.

In a 4-level master key system, it is especially important to consider the traffic flow throughout the building.

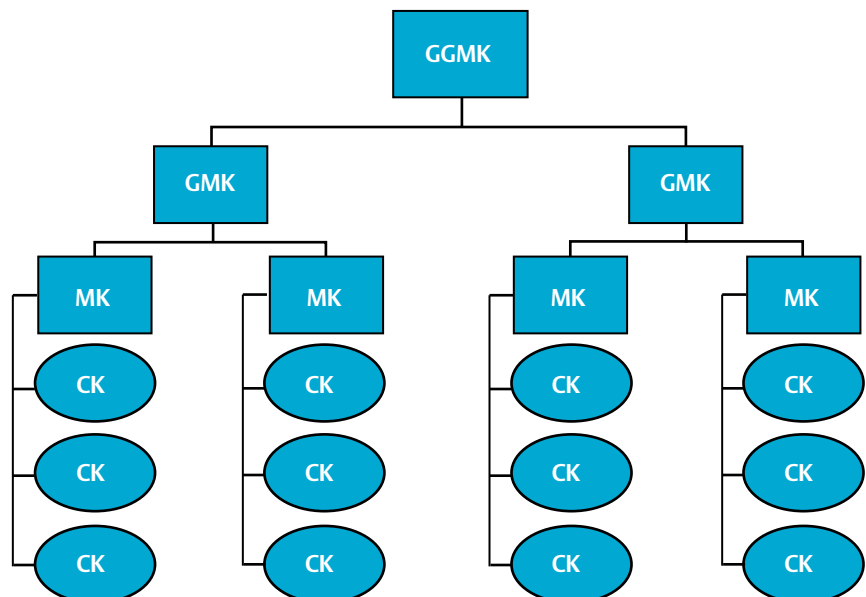

Key Symbols

Standard Key Symbols

A key symbol is an alpha and/or numeric (MK2, CK1, 1-1) designation that is used to properly identify the correct key combination for a door or group of doors.

2-Level System

Here are a few rules to consider when designing a 2-level system:

Rule #1: Change keys have numbers added to the letters or numbers of the master key they're under. In 2-level systems, it is these numbers that come last.

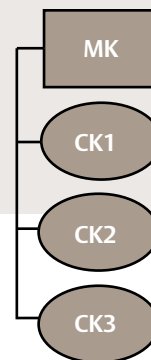

3-Level System

In systems with more than 2 levels, the change key numbers come last. Here we have a 3-level system, a grand master key system.

The change key numbers come last and the master keys have 2 letters. The new item here is the grand master key.

Rule #2: GMKs have only one letter or number.

Rule #3: Masters under the grand must start with the letters MK.

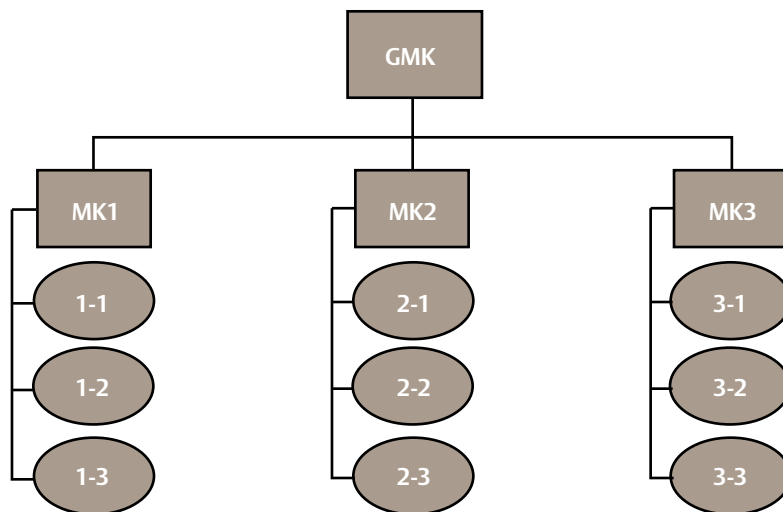

Key Symbols

Grand Master Pie “A”

A keying system is like a pie. You can cut it into many pieces, but the more pieces, the smaller each piece and the more there is to manage.

The larger you make one piece, the less remaining pie available.

Keep It Simple

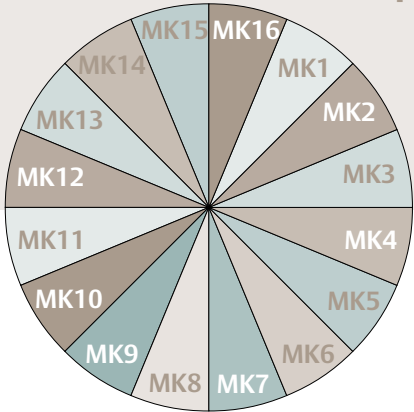

Many masters: “Top heavy” system with limited room for expansion

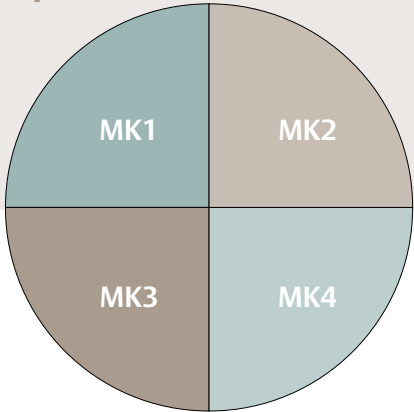

Fewer masters: preferable due to more expansion opportunities

The following represents a schematic of a level three (GMK) system. Your system may vary somewhat from this.

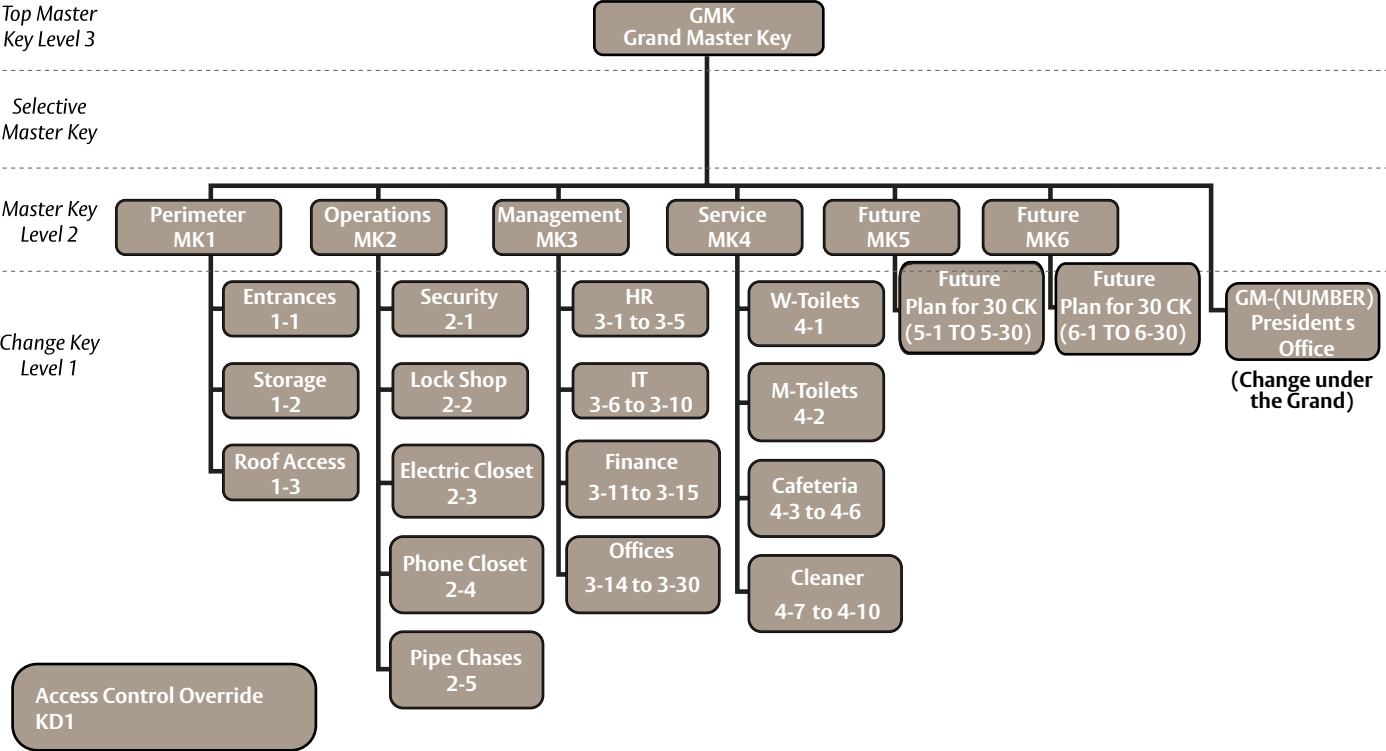

Key Symbols

4-Level System

In a 4-level system (great grand master key system) the first 4 rules still apply:

- It's a system of more than 2 levels, so the change key numbers come last
- Masters have 2 numbers or letters
- The first number matches the grand
- Grands have a single number

The new information here is the great grand.

Rule #5: The symbol for a great grand master key is GGMMK.

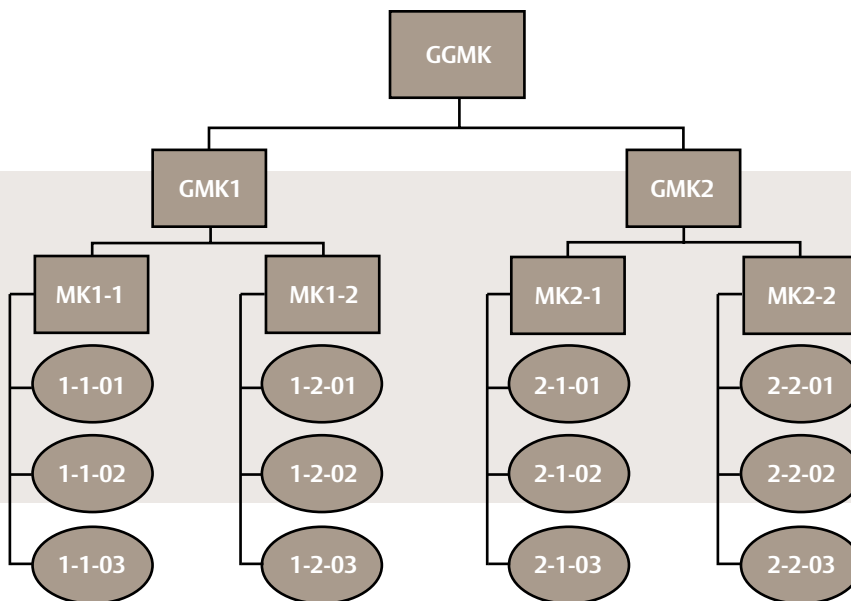

Special Keying Requirements

There are many other symbols for special keying requirements.

Selective Master Keys

- (ENG) Engineering key
- (CLR) Cleaners
- (SEC) Security key

Change Keys Under the Great Grand Master Key (GGMMK)

- GGM1 - The first change key directly under the GGMMK
- GGM2 - The second change key directly under the GGMMK
- and so on

Change Keys Under the Grand Master Key (GMK)

- GM-1 - The first change key directly under the GMK
- GM-2 - The second change key directly under the GMK
- and so on

Larger Systems

Multi Profile keyways may be used to accommodate larger systems and expansion requirements necessary for future development. Plan your largest systems wisely from the start; with the use of multi profile keyways the bittings are repeated on other key sections. Let the manufacturer decide how to apply keyways to best suit the job at hand based on the numerical expansion parameters.

System Expansion

Always consider the expansion when designing master key systems. A master key system is like a rubber band. When stretched vertically (more levels of keying) it contracts horizontally (fewer combinations at each level). When stretched horizontally (more combinations at each level) it contracts vertically (fewer levels of keying are available). Keep this in mind when designing keying systems and submitting expansion parameters to the manufacturer. Supply actual numbers for expansion under every master level key, avoid using percentages.

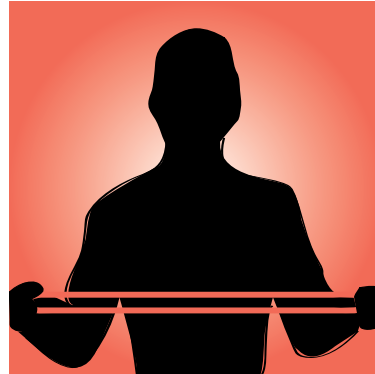

Define Expansion Parameters

- Levels of keying
- Realistic numbers at each level
- All branches of system
- Mixtures of cylinder mechanisms

It's absolutely critical for the health and longevity of the system to establish realistic expansion parameters. See sample expansion specification section below and note that actual numbers are shown for each level.

Define realistic expansion for the number of masters under each grand, and changes under each master for all parts of the system. If different cylinder mechanisms will be mixed on the project, define where each will be used.

Sample Expansion Specification

Planning should include future building additions or partitions, and rekeying individual door or groups of doors if change keys or master keys are lost or stolen.

Look as far into the future as possible, but don't "go wild." Stay realistic, and stay away from percentages.

Here is an example of clear expansion parameters.

- Establish a new grand master key system
- Plan 20 changes directly under the grand
- Plan 10 master keys
- Plan 50 changes each for each master

What You Must Know

In many cases, expansion is a guess, but it must be the best possible guess. Ask questions like these:

- How many more buildings in this system?
- How do future buildings fit into the structure?
- What is the maximum number of keyed openings per floor/department/areas that are keyed differently?
- Where does this job fit into the total final system?
- Are future buildings planned?
- How do they fit into the overall system?
- What is the maximum conceivable number of keyed openings on a floor after maximum partitioning?
- Will all cylinder mechanisms be under the same system?

Theoretical Numbers Reduced

The master key system's overall capacity is affected by the following factors:

- Mechanical factors of cutting the key
- Theoretical numbers are first reduced by a mechanical factor, called the MACS (Maximum Adjacent Cut Specification)
- Use of multiple selective keys
- Cross keying

System Expansion

Cross Keying

Cross keying a cylinder allows additional keys other than its own key set to operate it. There are two types of cross keying: controlled and uncontrolled. See the glossary beginning on page 13 for additional information.

Cross keying is always designated by the letter “X”: prefix X to the key symbol, then list each key symbol that is required to also operate the cylinder. Example: X1-1-01, OB (operated by) 1-1-02,1-1-03,MK1,GMK.

Cross keying:

- Should be avoided
- Does not fit in a system that has been designed for security
- Normally results in unplanned key interchange
- Reduces the overall system capabilities
- Increases the risk of unauthorized key interchange

Convenience May Reduce Cylinder Security and Hinder System Expansion

Cross keying not only reduces security, it reduces expansion possibilities. Uncontrolled cross keying (between different masters or grands) reduces it even more. If one master is lost, so are all of its changes. If one grand is lost, so are all of its masters and all of their changes. This can add up to thousands of combinations lost. Therefore, supplying extra keys is recommended rather than jeopardizing the integrity of the master key system by allowing this convenience.

An example of cross keying is when two or more different keys such as 1-1-01 and 1-1-02 are both required to operate the same cylinder. This reduces the cylinder’s security. When the cross keying occurs under all the same higher level keys, such as 1-1-01 and 1-1-02, it is known as controlled cross keying. When it combines keys under different higher level keys, such as 1-1-01 and 1-2-01, it is known as uncontrolled cross keying.

In addition to reducing the security of the cylinder, cross keying usually imposes limits on the flexibility and expansion of the overall keying system. This is especially true of uncontrolled cross keying. For these reasons, it is strongly recommended to allow personnel to carry more than one key. Cross keying should be discouraged whenever possible. However, when cross keying is required, it is specified below, and should be summarized at the beginning of each order.

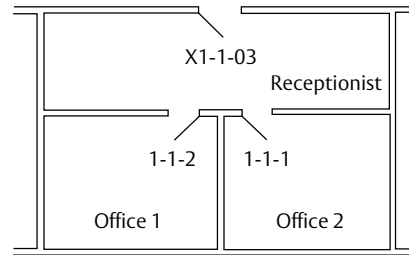

X1-1-03 operated by 1-1-2, 1-1-1, MK1 AND GMK.

Case #1: Cylinder requires its own change key. The illustration depicts part of a small medical building where two doctors share a common receptionist. The receptionist gets the 1-1-03 key. Each doctor carries a key that operates only one office, but is also cross keyed into the entrance from the corridor.

Determine the symbol of the change key. Then prefix the letter X (example: X1-1-03). Then list all keys that are to operate in an “operated by...” phrase. Example: “X1-1-03 operated by 1-1-2,1-1-1,MK1 AND GMK”. Note that X is a cylinder specification only. The keys for cylinder X1-1-03 are designated 1-1-03.

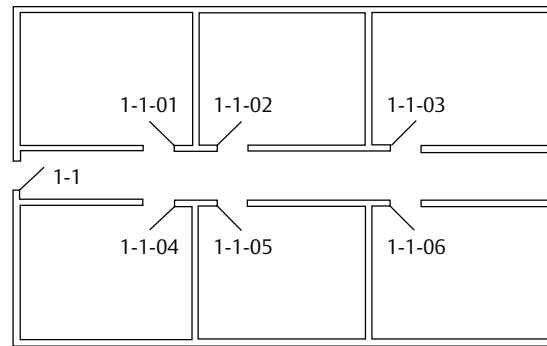

1-1 operated by 1-1-01 through 1-1-06, MK1 AND GMK.

Case #2: Cylinder does NOT require its own change key. This illustration depicts a section of a floor in a dormitory. Each student’s bedroom key operates the hall door lock. There is no need to construct a key that operates only the hall door.

In this case, place an X at both the beginning and end of the symbol and a number between them. Example: X1X, X2X, etc. Again, always include the “operated by...” phrase with a complete listing of key symbols to operate.

Designing Master Key Systems

Step 1: Meeting Security Objectives

Determine the level of access for each opening requiring a cylinder.

Here are the different types of cylinder mechanisms.

- Conventional “open & restricted keyways”
 - Not contract controlled
 - Key blanks are readily available
- Patented locking system
 - Administrative documents will be required between the lock manufacturer and owner
 - Key blank distribution restrictions are in place
- Security (secondary locking mechanisms)
 - Provides resistance against picking and manipulation
- High security (Aust. Standard AS4145.2 2008 SC7 or greater)
 - Provides resistance against picking / manipulation and drilling

When access control devices are furnished with a key override feature special consideration should be given regarding its keying.

- Stand-alone access control locking devices (at door wiring)
 - To facilitate multiple users through common doors
- Integrated locking systems (hardwired into access control systems)

Step 2: Planning

Establish the level of the master key system. The higher the level, the less secure.

Before determining the level ask these very important questions:

- Who, if anyone, is authorized to carry the top master key?
- Who carries master keys and change keys?
- Does every employee receive a key / do they need a key?

Select the level:

- Level two – “Simple Master Key System”
 - Change key and master key only
- Level three – “Grand Master Key System”

- Change key, master key, and grand master key
- Level four – “Great Grand Master Key System”
 - Change key, master key, grand master key, and great grand master key
- With more levels, additional internal components are required in the cylinder. This increases the possibility of unauthorized key interchanges

Separate internal departments in the building(s) into departments, buildings or geographic areas.

- Perimeter
 - Including all exterior doors, roof surfaces, gates and fences, and adjacent buildings
- Core Areas (Operations)
 - Sensitive areas crucial to daily operations, such as plant engineering, security and mechanical operations
- Management
 - Areas that are vital for daily business activities, including human resources, administration, executive offices, IT, and accounting
- Services
 - Areas that provide employees and visitors with services, such as restrooms, medical treatment areas, housekeeping, food service, retail (unless it's a leased outside source)
- Unique Applications
 - Door openings requiring access control hardware where key override is required, or any other special application
- Tenants
 - Any tenants that are not part of the building
- It is recommended to establish a separate system for those areas requiring security type cylinder mechanisms

Continued on next page

Step by Step

Step 3: Assigning Key Symbols

Use an alpha and/or numeric designation to properly identify the correct key combination for a door or group of doors. Here are some helpful hints:

- KISS “Keep It Simple System”
- Lowest level possible
- Key to the building security objectives NOT to the convenience of the keyholders
 - Determine if the system is to be designed for security or convenience (see page 1)
- Key alike within master key groups as much as possible
 - Avoid “top heavy” systems (example: few change keys used under numerous masters)
- Avoid cross keying, especially with patented locking systems and higher

Step 4: Key Control and Key Management

Establish key hierarchy, key issuing policies and procedures, and administrative disciplines.

- What disciplinary action(s) will be put into place for violations?
 - Fines or deposits
 - Lost keys
 - Keys not returned
 - Will there be a key receipt required? Where will that be kept?
- What is the role of the key control authority?
 - Authorized to purchase
 - Responsible for key control administration
 - Maintains key control software and all transactions
- Provide adequate quantity of keys
 - Top master keys - limit the number of these to only a few
 - Master keys - also limit the number of these
 - Change keys per key set and/or per keyed alike sets
 - Special purpose keys; Control keys - limit the number of these
- With whom or where will the key blanks be kept?

- Who is authorized to cut keys?
 - What form of work order will be used to authorize cutting of keys?
 - Who will sign the work order?
 - What records will be kept, and where?
- What type of reports will be required?
 - Overdue keys
 - Mis-cut keys
 - Who receives the reports?
- Once a key has been cut, what instructions are given to the recipient?
 - Key receipt recommended
- Ensure that all transactions are recorded by the key control authority
- ENFORCEMENT FROM THE START!
Support and back those who are responsible for maintaining and servicing the system

Step 5: Service and Maintenance

Follow proper service schedules and procedures. Recommendations include the following:

- Utilize an in-house or outside locksmith
 - Ensure proper training
 - Establish key cutting log
 - Establish service request procedures
- Have service equipment available
 - Key kit
 - Code cutter that complies with system’s depths and spacing specifications
 - Locksmithing tools, fixtures and accessories
- Establish stock levels and requirements to avoid misuse of multi-section key blanks
 - Additional cylinders ready for emergencies
 - Additional key blanks (of all keyways)

Step 6: Intellectual Property

- Determine who will own the intellectual property or copyright of the system design & code permutations.

This glossary relates to ASSA ABLOY Australia key systems education and should not be considered universal. Cylinder and Keying terminology has evolved over many years and while it is generally understood by those conversant with lock and key hardware, the accompanying glossary may assist to clarify any areas of doubt.

1. Terms and definitions are to be reprinted in their entirety.
2. Credit is to be given to Australian Standard AS 4145.1-2008, (Locksets and hardware for doors and windows).

ACCESS CONTROL

The means by influencing and regulating the flow of persons through a doorway

ALL – SECTION KEY BLANK

The key section that enters all keyways of a multiplex system.

AUTHORIZED KEY CUTTER

A business or person authorized by the lock cylinder manufacturer or agent to cut or bit that manufacturer's or agent's restricted keys.

BARREL

See plug

BITTED KEY

Generally means a cut key.

BITTING

1. The number(s) that represent(s) the dimensions of the key.
2. The actual cut(s) or combination of a key.

BITTING LIST

A listing of all the key combinations used within a system. The combinations are usually arranged in order of the Bottom Pins and Master Pins.

BOW

The portion of the key that serves as a grip or handle.

BROACH

A tool used to cut the keyway into a cylinder plug or barrel. A term also used for the keyway shape.

BUMPING

One of many methods used to open locks with the use of "bump keys" that leave no sign of physical attack.

CAM

A rotating lever attached to the end of the cylinder plug to activate the lock mechanism.

CHANGE KEY

See servant key

COMBINATE

To set a combination in a lock, cylinder, or key.

CONSTRUCTION CYLINDER

Temporary keyed cylinders installed during construction, removed and replaced with final keyed cylinders after construction is complete. This system ensures that keys used during construction cannot operate after final cylinders are installed.

CONSTRUCTION KEYING

Alternative method to a construction cylinder where the keyed cylinders are supplied with a construction key system when it is removed prior to building completion by the insertion of the owner key or by the removal of a split key plug.

CONSTRUCTION MASTER KEY (CMK)

A key normally used by construction personnel for a temporary period during building construction. It may be rendered permanently inoperative without disassembling the cylinder.

CONTROLLED CROSS KEYING

A condition in which two or more different keys of the same level of keying and under the same higher level key(s) operate one cylinder by design. *Note: This condition could severely limit the security of the cylinder and the maximum expansion of the system when (1) more than a few of these different keys operate a cylinder, or (2) more than a few differently cross keyed cylinders per system are required.*

CREDENTIAL

See Change Key

CROSS KEYING

The process of combining a cylinder (usually in a master key system) to two or more different keys which would not normally be expected to operate it together. See also "controlled cross keying" and "uncontrolled cross keying."

CUT KEY

A key that has been bitted or combined.

CYLINDER

The assembly incorporating the key-operated mechanism.

CYLINDER CORE

See plug

Glossary

DIFFERS

The variation between locks of similar design, which allow each lock to be operated only by its own key.

DIRECT KEY CODING

A code marked on a key or locks which, with no reference to another series of codes, discloses the key cuts for creating a workable key.

DISC

See tumbler

DOUBLE-BITTED KEY

A key having bittings or cuts on two sides to actuate the tumblers of the lock.

DUMMY CYLINDER

A non-functional facsimile of a rim or mortise cylinder used for appearance only, usually to conceal a cylinder hole.

EFFECTIVE DIFFER

Difference between key mechanisms of similar design, achieved only by the movable retainers, which allows each key mechanism to be operated only by its own key. The number of effective differs is equal to the number of theoretical after deduction of the undesirables, suppressed by the manufacturer due to technical constraints.

GRAND MASTER KEY (GMK)

A key, within a system, that operates all locks in a number of separate groups that have their own Master keys.

GREAT GRAND MASTER KEY (GGMK)

The same as GMK but usually consisting of more than one GMK group, which are then controlled by one GGMK key.

GUEST KEY

A hotel/ motel room key that is used by a guest, usually keyed to differ under a master key group.

HIGH SECURITY CYLINDER

A cylinder that offers a greater degree of resistance to any two or more of the following: picking, impressioning, key duplication, drilling or other forms of forcible entry.

HOUSING CYLINDER

The part of a locking device that is designated to hold a core.

IMPRESSIONING

A method of determining the key cuts, using a key blank or similar device, inserted in the keyway.

INDIRECT KEY CODING

A code marked on a key or lock, which requires reference to another series of codes to disclose the key cuts for creating a workable key.

INDIVIDUALLY KEYED

See keyed to differ

KEY

The device that is intended to activate the lock mechanism or cylinder.

KEY BIT

Generally a cut in a key.

KEY BITTING ARRAY (KBA)

A matrix (graphic) display of all possible bittings for change keys and master keys as related to the top master key.

KEY BLANK

An uncut key.

KEY CABINET

A cabinet with hooks, Velcro®, or other means designed to store keys systematically.

KEY CHANGES

The number of differs available within a key system.

KEY CODE

A record of key bitting.

KEY CONTROL

1. Any method or procedure that limits unauthorized acquisition of a key and/or controls distribution of authorized keys.
2. A systematic organization of keys and key records.

KEY INTERCHANGE

An undesirable condition, usually in a master key system, whereby a key unintentionally operates a cylinder or lock.

KEY PROFILE

The shape of the cross-section of the key that matches the broach.

KEY SECTION

The exact cross sectional configuration of a key blade as viewed from the bow toward the tip.

KEY SYMBOL

A designation used for a key combination in the standard key coding system, e.g. GMK, MK, 1-1, etc.

KEY SYSTEM

See maison key system, master key system and profile key system.

KEY SYSTEM SCHEMATIC

A drawing with blocks utilizing keying symbols, usually illustrating the hierarchy of all keys within a master key system. It indicates the structure and total expansion of the system.

KEYED ALIKE (KA)

Indicates identical key for two or more locks.

KEYED DIFFERENT (KD)

Of or pertaining to a group of locks or cylinders, each of which is or is to be combined differently from the others. They may or may not be part of a keying system.

KEYED TO DIFFER

Indicates that a different key is needed to activate each lock.

KEYED UNLOCKABLE

Indicates that the locking operation is activated without the aid of a key and the unlocking operation is performed by a key.

KEYWAY

The opening in the plug that is shaped to accept a key blade of proper configuration.

KEYING

Any specification for how a cylinder or group of cylinders are or are to be combined in order to control access.

KEYING CONFERENCE

A meeting of the end-user and the keying system supplier at which the keying and levels of keying, including future expansion, are determined and specified.

KEYING SCHEDULE

A detailed specification of the keying system listing how all cylinders are to be keyed and the quantities, markings, and shipping instructions of all keys and/or cylinders to be provided.

KEYWAY

1. The opening in a lock or cylinder that is shaped to accept the key bit or blade of a proper configuration.
2. The exact cross sectional configuration of a keyway as viewed from the front. It is not necessarily the same as the key section.

LEVELS OF KEYING

The divisions of a master key system into hierarchies of access, as shown on page 5.

LOCK SYSTEM

See key system.

MAISON KEY SYSTEM

A keying system where a group of different keys will operate a common lock.

MASTER KEY

1. A key that operates all the master keyed locks or cylinders in a group, each lock or cylinder usually operated by its own change key.
2. To combine a group of locks or cylinders such that each is operated by its own change key as well as by a master key for the entire group.

MASTER KEY SYSTEM

A system where locks are passed by two levels of keys. The lower level of key (keyed to differ) fits only that lock or those locks keyed alike. The higher level (master key) fits all locks in the system.

MASTER KEYED

Of or pertaining to a cylinder or group of cylinders that are or are to be combined so that all may be operated by their own change key(s) and by additional key(s) known as master key(s).

MULTI PROFILE KEY SYSTEM

1. A series of different key sections that may be used to expand a master key system by repeating bittings on additional key sections. The keys of one key section will not enter the keyway of another key section. This type of system always includes another key section that will enter more than one, or all of the keyways.
2. A keying system that uses such keyways and key sections.

PATTERN KEY

1. An original key kept on file to use in a key duplicating machine when additional keys are required.
2. Any key that is used in a key duplicating machine to create a duplicate key.

PIN TUMBLER

Usually a cylindrical shaped tumbler. Three types are normally used: bottom pin, master pin and top pin.

PLUG / BARREL

The part of a cylinder that contains the keyway, with tumbler chambers usually corresponding to those in the cylinder shell.

PROFILE KEY SYSTEM

See multi-element profile key system.

PROJECT KEYING

See construction keying.

RESTRICTED KEY

A key that can only be obtained through an authorization system.

RESTRICTED PROFILES

Key profiles and broaches that are generally used in special keying systems and are often the subject of registered design.

Glossary

SELECTIVE MASTER KEY

An unassociated master key that can be made to operate any specific lock(s) in the entire system in addition to the regular master key(s) and/or change key(s) for the cylinder without creating key interchange. Examples include:

- (ENG) Engineering key
- (SEC) Security key

SERVANT KEY

The individual key to a lock in a master key system.

SERVICE KEY

See servant key.

SERVICES KEY

A servant key used to operate a number of locks (e.g. locks for fire services, building services or emergency services).

SHEAR LINE

A location in a cylinder at which specific tumbler surfaces must be aligned, removing obstruction(s) that prevent the plug from moving.

SHELL / HOUSING

The part of the cylinder that surrounds the plug and usually contains tumbler chambers corresponding to those in the plug.

SINGLE KEY SECTION

An individual key section which can be used in a multiprofile key system.

SIGNATORY

The person (or persons) who controls and manages the key system.

SPOOL PIN

A double ended mushroom pin.

SKD

Abbreviation for "single keyed", normally followed by a numerical designation in the standard key coding system, e.g., SKD1, SKD2, etc. It indicates that a cylinder or lock is not master keyed but is part of the keying system.

STANDARD KEY CODING SYSTEM

An industry standard and uniform method of designating all keys and/or cylinders in a master key system. The designation automatically indicates the exact function and keying level of each key and/or cylinder in the system, usually without further explanation.

SURREPTITIOUS ENTRY

The use of entry or bypass techniques that cannot be detected via disassembly and detailed inspection of lock components, eg. bumping.

TAILPIECE

An actuator attached to the rear of the cylinder, parallel to the plug, typically used on rim, key-in-knob or special application cylinders.

TOP PIN

The upper pins in a pin tumbler cylinder.

TRACEABLE KEY

Also referred to as a restricted key. A key that is identifiable as part of a restricted key system. It is marked with a system number, a ranking and an issue number.

TUMBLER

A component of a lock or cylinder that prevents operation of the lock mechanism, except with insertion of the correct key. Tumbler may take the form of pins, discs, levers, bars, wafer or retainers.

UNCONTROLLED CROSS KEYING

A condition in which two or more different change keys under different higher level keys operate one cylinder: e.g., X1-1-01, OB (operated by) MK1, 1-1.* *Note: This condition severely limits the security of the cylinder and the maximum expansion of the system, and often leads to key interchange.*

VISUAL KEY CONTROL (VKC)

A specification that all keys and the visible portion of the front of all lock cylinders be stamped with standard keying symbols.

WAFFER

See tumbler.

X

Symbol used in hardware schedules to indicate a cross-keyed condition for a particular cylinder, e.g. X1-1-01, OB (operated by) 1-1-1, 1-1-2, MK1, GMK.

ZERO BITTED

Of or pertaining to a cylinder which is or is to be combined to keys cut to the manufacturer's reference number "0" bitting.

Levels of Keying

This chart shows the divisions of a master key system into hierarchies of access. The standard key coding system has been expanded to include key symbols for systems of more than four levels of keying. For security reasons, systems higher than four levels are not recommended.

Two Level System

Level of Keying	Key Name	Abbreviation	Key Symbol
Level II	Master Key	MK	MK1
Level I	Change Key	CK	1-1, 1-2, etc.

Three Level System

Level of Keying	Key Name	Abbreviation	Key Symbol
Level III	Grand Master Key	GMK	GMK
Level II	Master Key	MK	MK1, MK2, etc.
Level I	Change Key	CK	1-1, 1-2, 2-1, 2-2, etc.

Four Level System

Level of Keying	Key Name	Abbreviation	Key Symbol
Level IV	Great Grand Master Key	GGMK	GGMK
Level III	Grand Master Key	GMK	GMK1, GMK2, etc.
Level II	Master Key	MK	MK1, MK2, etc.
Level I	Change Key	CK	1-1, 1-2, 2-1, 2-2, etc.

Five Level System*

Level of Keying	Key Name	Abbreviation	Key Symbol
Level V	Great Great Grand Master Key	GGGMK	GGGMK
Level IV	Great Grand Master Key	GGMK	GGMK1, GGMK2, etc.
Level III	Grand Master Key	GMK	GMK1, GMK2, etc.
Level II	Master Key	MK	MK1, MK2, etc.
Level I	Change Key	CK	1-1, 1-2, 2-1, 2-2, etc.

Six Level System*

Level of Keying	Key Name	Abbreviation	Key Symbol
Level VI	Great Great Grand Master Key	GGGMK	GGMK
Level V	Great Grand Master Key	GGMK	GGMK1, GGMK2, etc.
Level IV	Grand Master Key	GMK	GMK1, GMK2, etc.
Level III	Master Key	MK	MK1, MK2, MK3, etc.
Level II	Sub-Master Key	SMK	SMK1, SMK2, etc.
Level I	Change Key	CK	1-1, 1-2, 2-1, 2-2, etc.

* Shown for example only, this level is not recommended for secured master key systems.

KS.3 System Schematic Worksheet (Level 3)

System Design Worksheet

Job Reference _____
 Information _____
 Date _____ By _____
 Approved By _____
 Date _____

Grand Master Key
 Area/Dept. _____
 # of Changes _____

Page of

Selective Control Key Used with IC cores only
 CMK Construction Master Keying

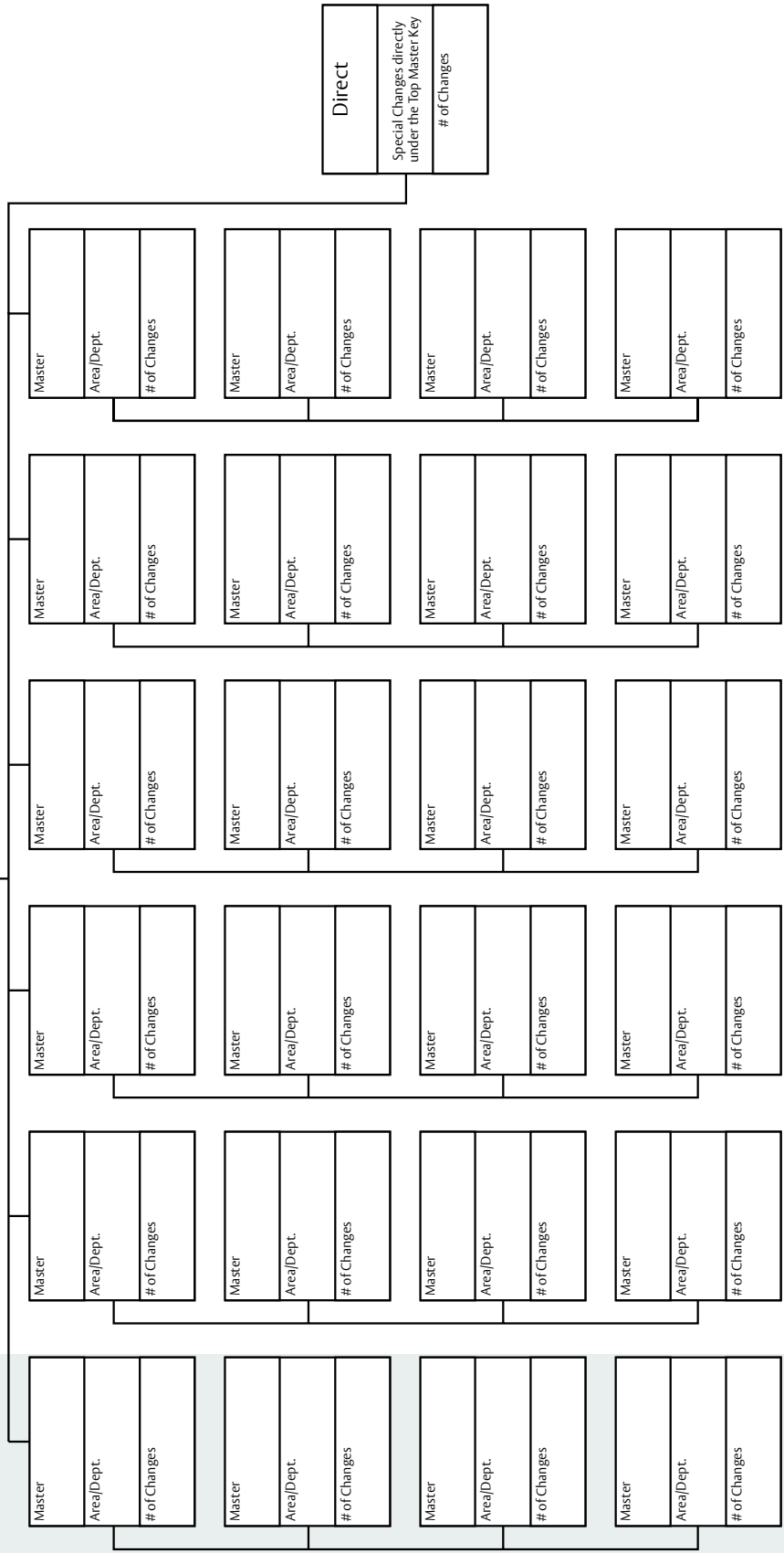

Single Keyed Changes

SKD _____
 Door# or Area _____

Special Instructions

SKD _____
 Door# or Area _____

See next page for sample layout.
 Additional forms available separately.

NOTE: See glossary on pages 13-16 for terms and definitions.
 For assistance, contact your local ASSA ABLOY Australia team.

KS.3 System Schematic Worksheet (Level 3)

Job Reference Uptown Hospital
 Information New Wing
 Date 5/12/08 By J. Smith
 Approved By M. Blogs
 Date 5/14/08

Grand Master Key
GMK
 Area/Dept. Top Master Key

Instructions: Indicate the highest level master key symbol in the top line of each box. Identify the area or department, indicate the total number of key changes, including future expansion. Do not use letters I, O, or Q in key symbols.

Page 1 of 1

Selective _____
 Master Key _____
 Control Key Used with IC cores only
 CMK Construction Master Keying

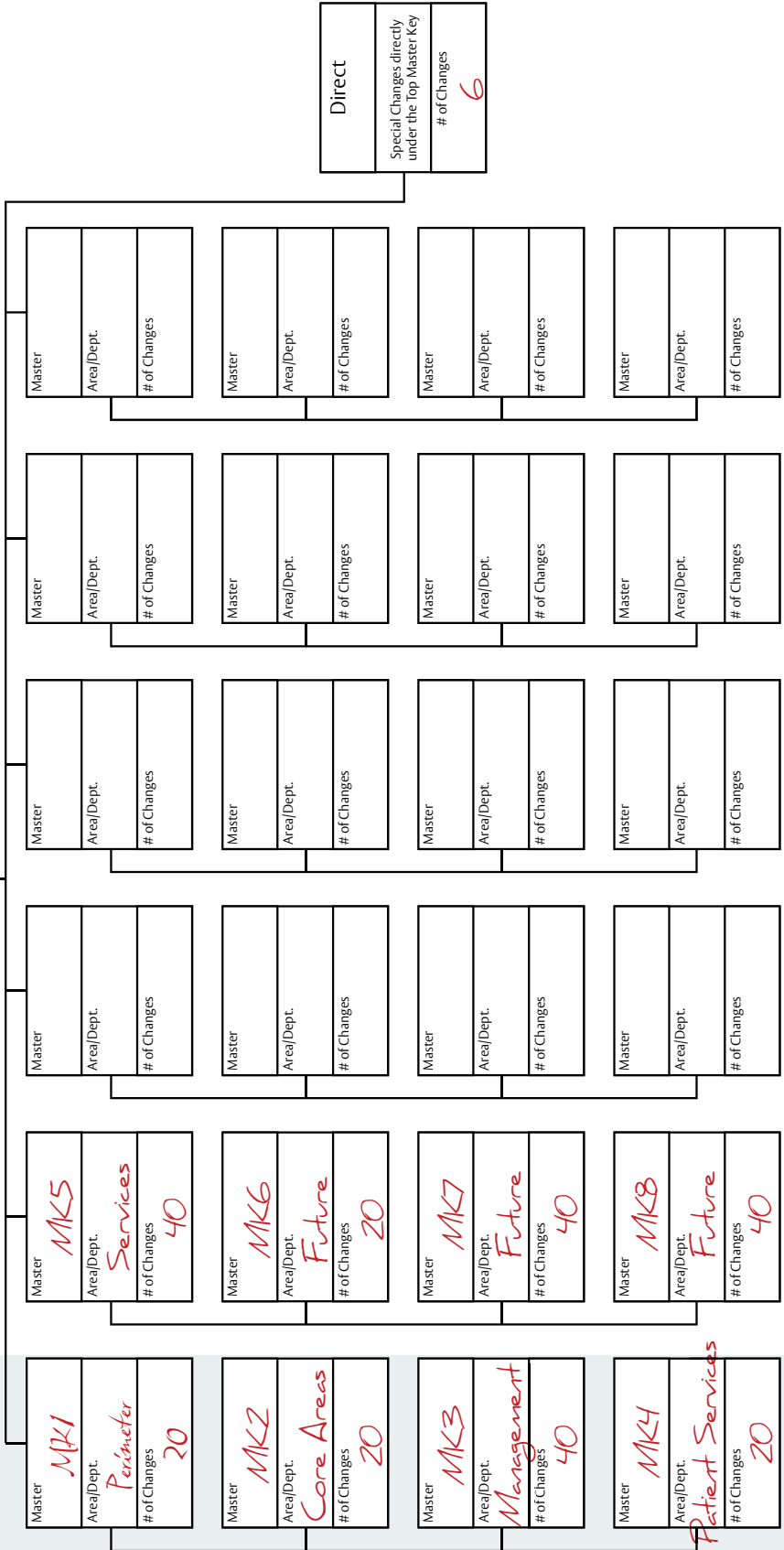

Special Instructions

Single Keyed Changes

SKD 3
 Door#/or Area Pharmacy

SKD 2
 Door#/or Area Drug Carts

SKD 1
 Door#/or Area Access Control

Change key only, will not be operated by any other key within the system

NOTE: See glossary on pages 13-16 for terms and definitions. For assistance, contact your local ASSA ABLOY Australia team.

ASSA ABLOY is the global leader in door opening solutions, dedicated to satisfying end-user needs for security, safety and convenience.

ASSA ABLOY is represented in all major regions, in both mature and emerging markets, with leading positions in Australia, Europe and North America.

As the world's leading lock group, ASSA ABLOY offers a more complete product range of door opening solutions than any other company in the market.

Head Office

ASSA ABLOY Australia Pty Limited
235 Huntingdale Road, Oakleigh
Victoria, 3166 Australia

1300 LOCK UP (1300 562 587)
info.au@assaabloy.com
assaabloy.com.au

