

Air Coupling Lock Range



We take the worry out of
protecting what's valuable to you.
Lockwood: *no worries*[®]

LOCKWOOD

ASSA ABLOY

25YEAR

**MECHANICAL
WARRANTY**

www.lockweb.com.au

Overview



The Lockwood Air Coupling Locks have been designed for the securing of Truck (Trailer) and industrial compressed air line applications. When attached to the air line this product provides security and safety.

Security: Whereby the air brakes air line fitting is effectively sealed when the lock is attached, preventing connection to the opposing fitting. In the case of a Trailer application this reduces the risk of the trailer being connected to a truck without authorisation.

Safety: In an industrial application the sealing of the air line can reduce the risk of an accidental connection of equipment when shut down for maintenance etc.

The Lockwood Air Coupling Lock range consist of two series, the AL Series and the TL Series.

AL Series

The AL Series comes with an integrated cylinder that can be keyed to most restricted key systems.

It is available in two models to suit both the ½" NPT female air coupling and the ½" NPT male air coupling.



TL Series

The TL Series is locked with a padlock. The locking point allows for use of a padlock with under 10mm shackle diameter.

It is available in two models to suit both the ½" NPT female air coupling and the ½" NPT male air coupling.

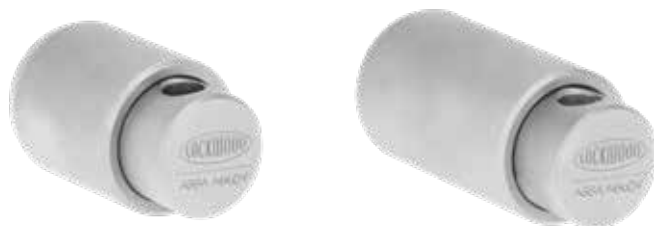

Air Coupling Types

Air Coupling Types

Air Couplings come in different sizes, the AL & TL Series are designed to work with ½ inch couplings;

- 1/2" NPT male coupling = AL Series 63 or TL Series 1/2IN
- 1/2" NPT female coupling = AL Series 81 or TL Series 28MM

Note: Air Couplings are not supplied.

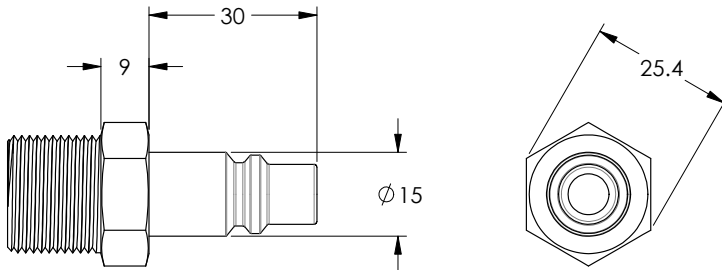

½" NPT male thread coupling

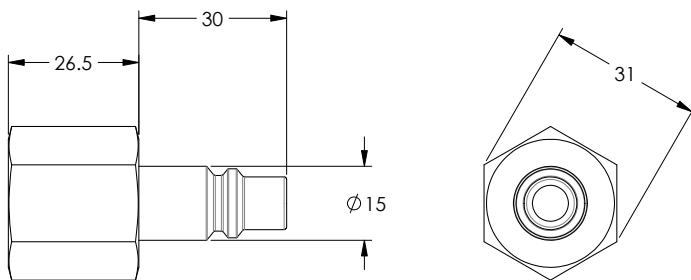

½" NPT female thread coupling

AL Series



AL Series

The AL Series comes with an integrated cylinder that can be keyed to most restricted key systems.

It is available in two models to suit both the ½" NPT female air coupling and the ½" NPT male air coupling.

Product Details

Dimensions	Diameter: 45mm
	Length: <ul style="list-style-type: none">• AL Series 63 - 96mm• AL Series 81 - 114mm
Materials	Inner Sleeve: Mild Steel Outer Sleeve: Case Hardened Steel
Function	Spring loaded function allowing for quick snap-on attachment to ½ inch air coupling fittings.
	Locked and unlocked by integrated cylinder. Key retained in unlocked position.
Finish	Chrome Plate (CP)
Cylinder	AL Series - 577 Synergy 3500 Series dual access lower cylinder.
Special Keying	Locks can be keyed to a number of controlled and/or specially keyed systems. These range from legally protected keys to protect against unauthorised duplication and can also include specially designed keying systems such as master key systems. This allows for different levels of mechanical access control.

AL Series

Dimensions

AL Series 63

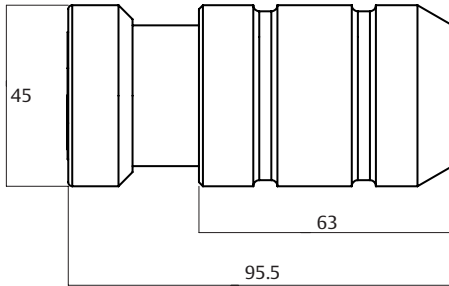

AL Series 81

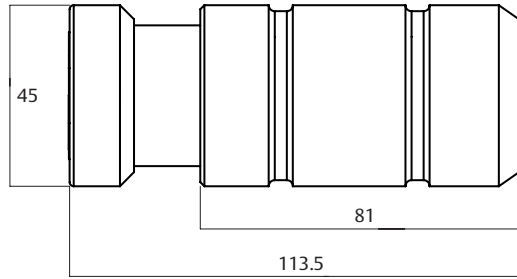

Part Numbers

Part Number	Description	Coupling Type
AL1/2/63MM##	AL Series 63 Air Coupling Lock	½" NPT male thread coupling
AL1/2/81MM##	AL Series 81 Air Coupling Lock	½" NPT female thread coupling

Note: ## in part number is exchanged for keying type.

KD = Keyed to Differ (Standard C4 profile 6 pin)

KA = Keyed Alike (Standard C4 profile 6 pin)

MK = Master Keyed (Standard C4 profile 6 pin)

TL Series



TL Series

The TL Series is locked with a padlock. The locking point allows for use of a padlock with under 10mm shackle diameter.

It is available in two models to suit both the 1/2" NPT female air coupling and the 1/2" NPT male air coupling.

Product Details

Dimensions	Diameter: 38mm
	Length: <ul style="list-style-type: none">• TL Series 1/2IN – 59mm• TL Series 28 – 79mm
Materials	Inner Sleeve: Mild Steel Outer Sleeve: Case Hardened Steel
Function	Spring loaded function allowing for quick snap-on attachment to 1/2 inch air coupling fittings.
Finish	Satin Chrome Pearl (SP)
Locking	The TL Series is locked by padlock. Padlocks are available separately and not included.
	Suits padlocks with a shackle diameter of under 10mm and minimum clearance height of 38mm.

TL Series

Dimensions

TL Series 1/2IN

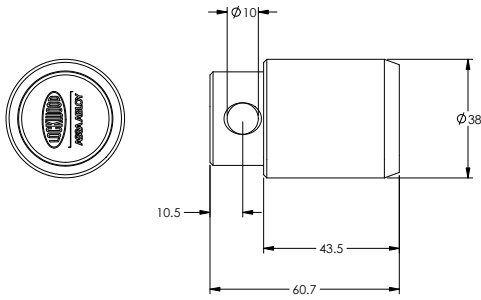

TL Series 28MM

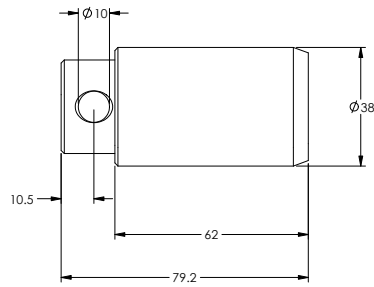

Part Numbers

Part Number	Description	Coupling Type
TL1/2IN	TL Series 1/2IN Air Coupling Lock	½" NPT male thread coupling
TL28MM	TL Series 28MM Air Coupling Lock	½" NPT female thread coupling

Note: Padlocks are available separately and not included.



ASSA ABLOY

Lockwood is the leading brand in the Australian locking industry. With an established reputation for high quality products, this iconic brand provides a wide range of locking solutions to residential housing, commercial, semi-commercial, building and industrial application markets. Lockwood is supported by an extensive distribution and after-sales support network. Our customers include retailers, architects, trade and industrial personnel, locksmiths and security dealers.

ASSA ABLOY is the global leader in door access solutions, dedicated to satisfying end-user needs for security, safety and convenience.

ASSA ABLOY is represented in all major regions, in both mature and emerging markets, with leading positions in Australia, Europe and North America.

**25YEAR
MECHANICAL
WARRANTY**

The Lockwood 25 Year Mechanical Warranty

Our belief that we manufacture the finest premium products available in today's market place is backed by the Lockwood 25 Year Mechanical Warranty, ensuring that Lockwood continues to keep Australians safe by delivering security and peace of mind.

For warranty terms and conditions, please visit www.lockweb.com.au or call **1300WARRANTY**

ASSA ABLOY Australia Pty Ltd
235 Huntingdale Road
Oakleigh, Victoria, 3166
Australia

1300 LOCK UP (1300 562 587)
lockweb.com.au

ASSA ABLOY New Zealand Ltd
6 Armstrong Road
Albany, Auckland, 0632
New Zealand

info.nz@assaabloy.com
Telephone +64 9415 7111
assaabloy.co.nz

