

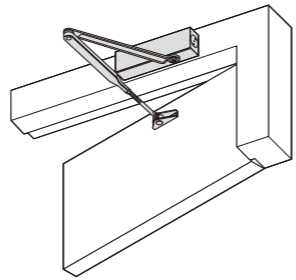

# 7726/726 SERIES 2-6 POWER ADJUSTABLE DOOR CLOSER

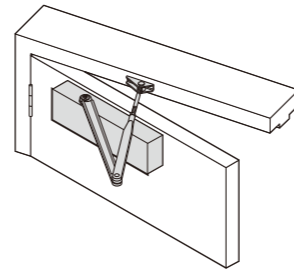

TRANSOM FIXING  
(RIGHTHAND DOOR PUSH SIDE)



REGULAR FIXING  
(LEFT HAND DOOR PULL SIDE)

Power Size	Max. Door Width	Max. Door Weight	Max. Door Opening	Min. Closing Torque	Number Turns	Direction
EN2	850mm	40kg	180°	13Nm	0	Adjust shoe bracket
EN3	950mm	60kg	180°	18Nm	0	-
EN4	1100mm	80kg	180°	26Nm	3	Clockwise
EN5	1250mm	100kg	180°	37Nm	6	Clockwise
EN6	1400mm	120kg	180°	54Nm	9	Clockwise

222

45

215

3-6

2

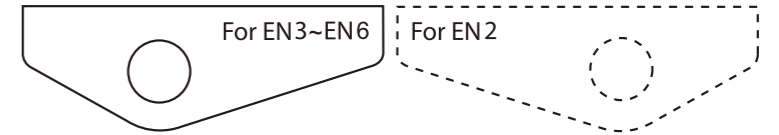

For EN3~EN6

For EN2

FOR OVER DOOR INSTALLATION  
(Min. Door Frame 65mm)

DOOR

DOOR FRAME

14

45

TOP OF DOOR

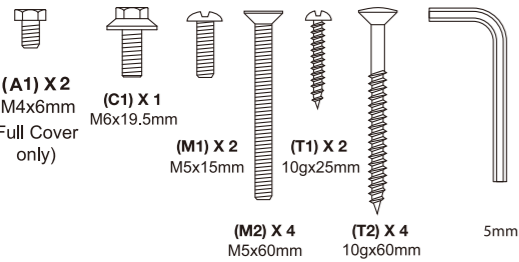

M = METAL T= TIMBER

Timber	drill Ø3
Metal	drill Ø4.2 and tap M5

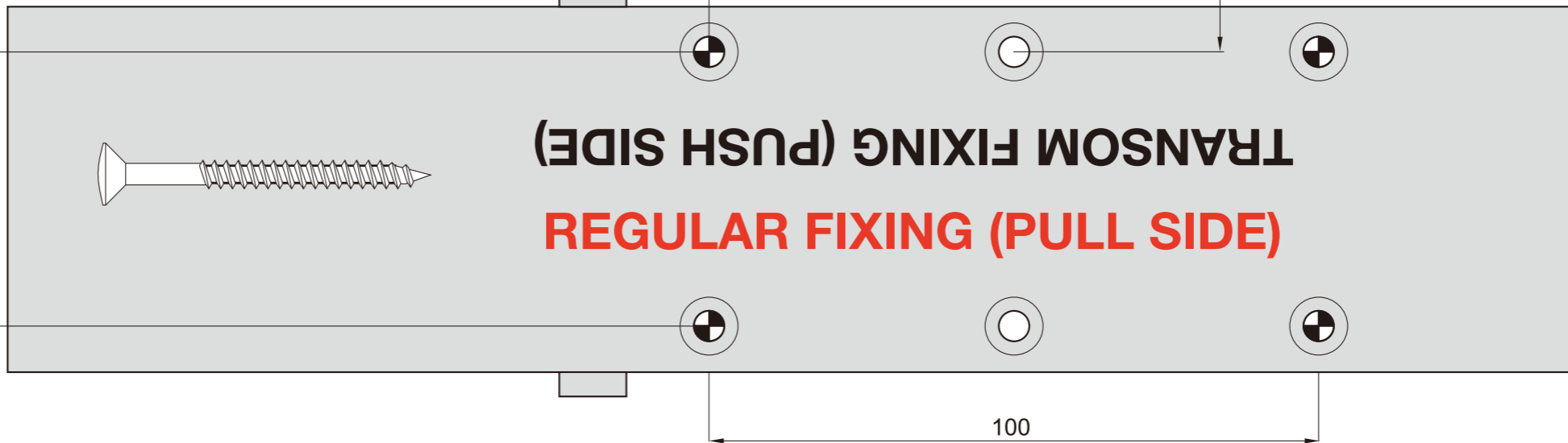

TRANSOM FIXING (PUSH SIDE)  
REGULAR FIXING (PULL SIDE)

**1** Align template to door. Mark & drill 4 mounting holes and 2 bracket holes as indicated on this sheet.

TRANSOM FIXING      REGULAR FIXING

**2** Screw body in place using screws as shown. Install arm and securely tighten. Separate and adjust threaded link arm 90° to door face.

**3** Adjust door controls to suit conditions.

The Delayed Action is an independent valve and can either be adjusted as part of the closing sequence or independently adjusted for delayed action

Closing sequence with Delayed Action  
 180° - 70° Control door speed with Delayed Action valve  
 70° - 15° Control door speed with Closing valve  
 15° - 0° Control door speed with Latching valve  
 70° - 180° Control with Backcheck valve

**4** • Fit front cover - clip on bottom first

To remove cover slide sideways

• Fit front cover

Power Size	Max. Door Width	Max. Door Weight	Max. Door Opening	Min. Closing Torque	Number Turns	Direction
EN2	850mm	40kg	180°	13Nm	0	Adjust shoe bracket
EN3	950mm	60kg	180°	18Nm	0	-
EN4	1100mm	80kg	180°	26Nm	3	Clockwise
EN5	1250mm	100kg	180°	37Nm	6	Clockwise
EN6	1400mm	120kg	180°	54Nm	9	Clockwise

# 7726/726 SERIES 2-6 POWER ADJUSTABLE DOOR CLOSER

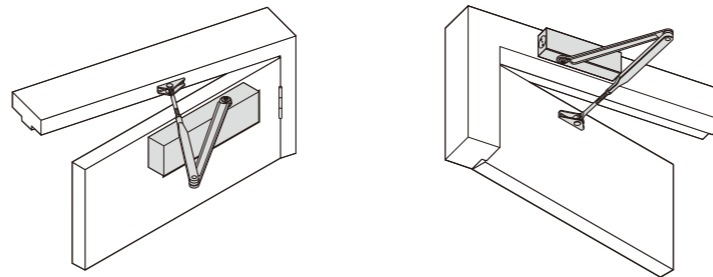

**REGULAR FIXING  
(RIGHT HAND DOOR PULL SIDE)**

**TRANSOM FIXING  
(LEFTHAND DOOR PUSH SIDE)**

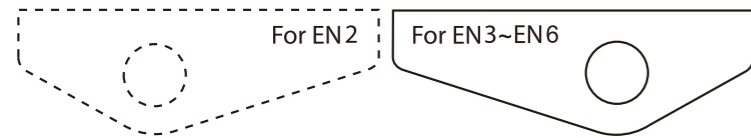

FOR OVER DOOR INSTALLATION  
TURN TEMPLATE THIS WAY UP  
(Min. Door Frame 65mm)



**TOP OF DOOR**

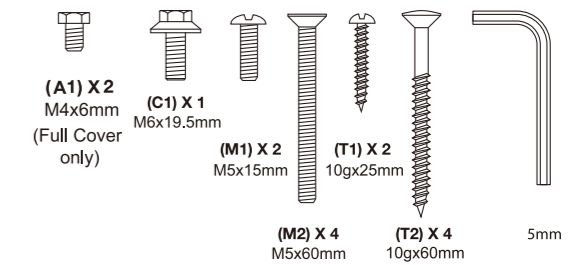
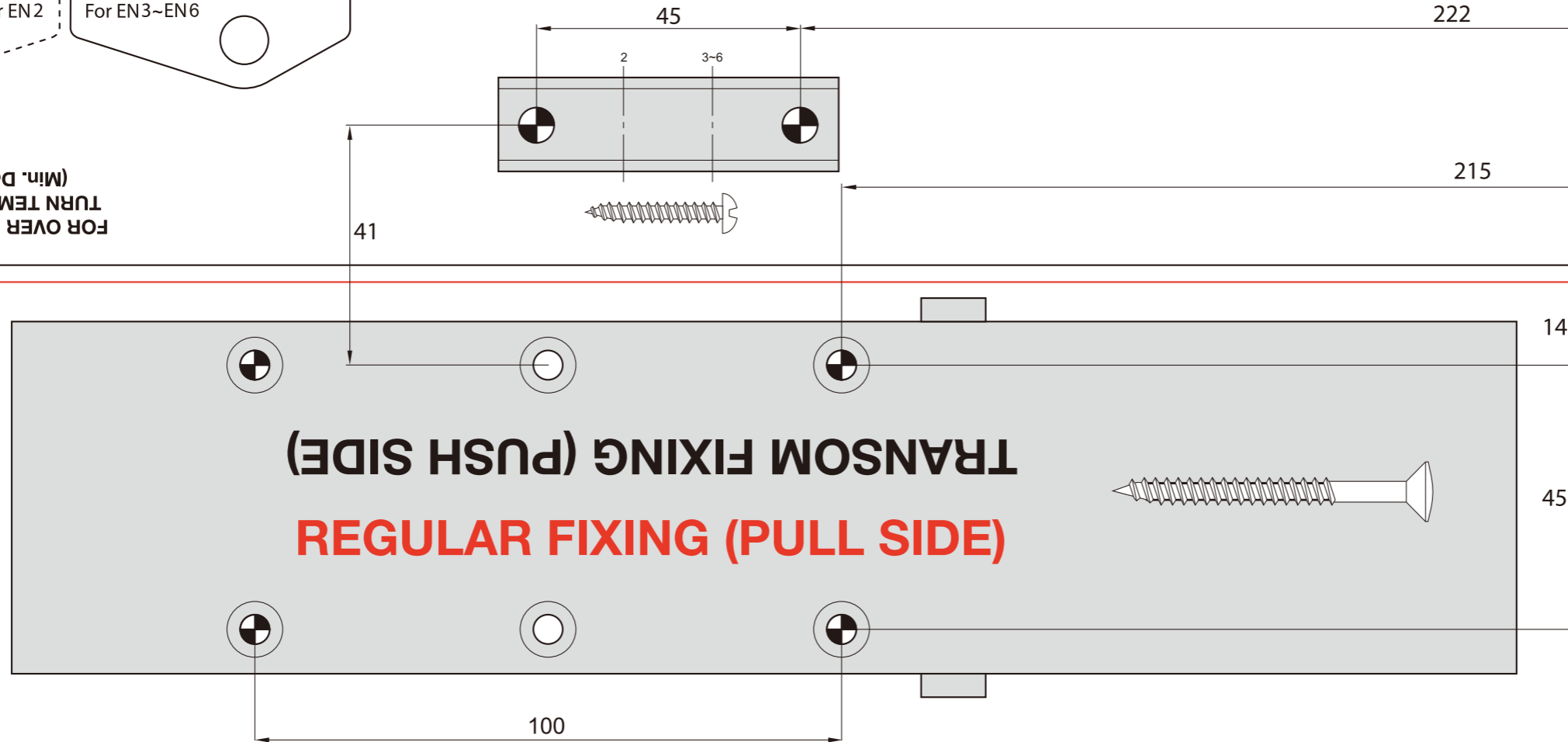

M = METAL T = TIMBER

Timber	drill Ø3
Metal	drill Ø4.2 and tap M5

**1** Align template to door. Mark & drill 4 mounting holes and 2 bracket holes as indicated on this sheet.

**REGULAR FIXING**      **TRANSOM FIXING**

**2** Screw body in place using screws as shown. Install arm and securely tighten. Separate and adjust threaded link arm 90° to door face.

**3** Adjust door controls to suit conditions.

The Delayed Action is an independent valve and can either be adjusted as part of the closing sequence or independently adjusted for delayed action

Closing sequence with Delayed Action

- 180° - 70° Control door speed with Delayed Action valve
- 70° - 15° Control door speed with Closing valve
- 15° - 0° Control door speed with Latching valve
- 70° - 180° Control with Backcheck valve

**4** • Fit front cover - clip on bottom first

To remove cover slide sideways

• Fit front cover

FOLD HERE